

RESISTENZE A CARTUCCIA ROD

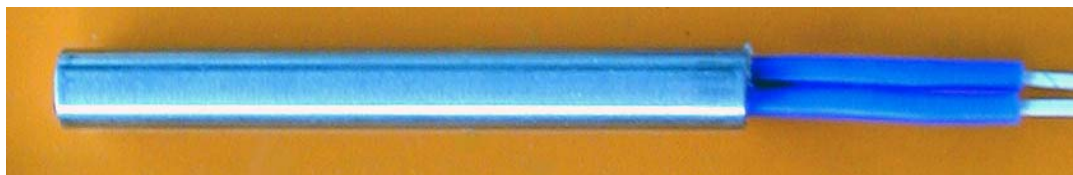

SPECIFICHE TECNICHE

SPECIFICHE TECNICHE											
ROD 6,5 mm <i>-0,02 / - 0,05</i>	LUNG [mm]	40	50	60	80	100	130	160			
	WATT 230V	100 / 125 / 160 / 175 / 200	125 / 160 / 200 / 250	125 / 160 / 200 / 250	160 / 200 / 250 / 315	200 / 250 / 315 / 350 / 400	250 / 400	315 / 400			
ROD 8 mm <i>-0,04 / - 0,08</i>	LUNG [mm]	40	50	60	80	100	130	160			
	WATT 230V	125 / 160 / 200	160 / 200 / 250	160 / 200 / 250 / 315	200 / 250 / 315 / 400	200 / 250 / 315 / 400	250 / 315 / 400	250 / 400			
ROD 10 mm <i>-0,04 / - 0,07</i>	LUNG [mm]	40	50	60	80	100	130	160	200		
	WATT 230V	125 / 160 / 200 / 250	160 / 200 / 250 / 315 / 400	160 / 200 / 250 / 315 / 400 / 500	200 / 250 / 315 / 400 / 500 / 630	250 / 315 / 400 / 500 / 630 / 800	250 / 315 / 400 / 500 / 630 / 800	315 / 400 / 500 / 630 / 800	400 / 500 / 630 / 800		
ROD 12,5 mm <i>-0,05 / - 0,08</i>	LUNG [mm]	40	50	60	80	100	130	160	200	250	300
	WATT 230V	160 / 200 / 250 / 315	160 / 200 / 250 / 315 / 400	200 / 250 / 315 / 400 / 500	250 / 315 / 400 / 500 / 630	315 / 400 / 500 / 630 / 800 / 1000	400 / 500 / 630 / 800 / 1000	500 / 630 / 800 / 1000 / 1250	630 / 800 / 1000 / 1250	800 / 1000 / 1250 / 1500	1000 / 1250 / 1500 / 2000
ROD 16 mm <i>-0,05 / - 0,08</i>	LUNG [mm]	50	60	80	100	130	160	200	250	300	
	WATT 230V	200 / 250 / 315 / 400	200 / 250 / 315 / 400	250 / 315 / 400 / 500 / 630 / 800	315 / 400 / 500 / 630 / 800 / 1000	400 / 500 / 630 / 700 / 800 / 1000 / 1250	500 / 630 / 800 / 1000 / 1250	630 / 800 / 1000 / 1250 / 1500 / 2000	1000 / 1500 / 2000	1000 / 1250 / 1500 / 1800	

SPECIFICHE COSTRUTTIVE E TOLLERANZE CONSTRUCTIVE SPECIFICATION AND TOLERANCES

POTENZA (WATTAGE)	+5% -10%
RESISTENZA (RESISTANCE)	+10% - 5%
RIGIDITA' DIELETTRICA (DIELECTRIC STRENGHT)	1500 V
ISOLAMENTO (INSULATION)	>10 MΩ
DISPERSIONE (LEAKAGE CURRENT)	<0.1 mA
MASSIMA TEMPERATURA SUL TUBO (MAXIMUM TUBE WORKING TEMPERATURE)	750°C

RESISTENZE A CARTUCCIA ROD T/C

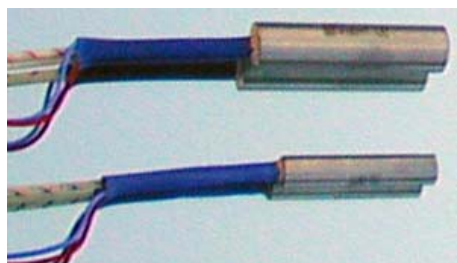

SPECIFICHE TECNICHE

SPECIFICHE TECNICHE											
ROD 6,5 mm <i>-0,02 / - 0,05</i>	LUNG [mm]	40	50	60	80	100	130	160			
	WATT 230V	125 / 160 / 200	125 / 160 / 200	160 / 200 / 250	200 / 250 / 315	250 / 315 / 400	315 / 400 / 500	315 / 400 / 500			
ROD 8 mm <i>-0,04 / - 0,08</i>	LUNG [mm]	40	50	60	80	100	130	160			
	WATT 230V	160 / 200	160 / 250	200 / 315	250 / 315 / 400	250 / 400	315 / 500	315 / 500			
ROD 10 mm <i>-0,04 / - 0,07</i>	LUNG [mm]	40	50	60	80	100	130	160	200		
	WATT 230V	160 / 200 / 250	200 / 250 / 315	200 / 250 / 315	250 / 315 / 400	315 / 400 / 500	315 / 400 / 500	400 / 500 / 630	500 / 800		
ROD 12,5 mm <i>-0,05 / - 0,08</i>	LUNG [mm]	40	50	60	80	100	130	160	200	250	300
	WATT 230V	200 / 250	200 / 315 / 400	250 / 400	250 / 400	400 / 630	400 / 630	500 / 800	630 / 1000	800 / 1250	1000 / 1500

SPECIFICHE COSTRUTTIVE E TOLLERANZE CONSTRUCTIVE SPECIFICATION AND TOLERANCES

POTENZA (WATTAGE)	+5% -10%
RESISTENZA (RESISTANCE)	+10% - 5%
RIGIDITA' DIELETTICA (DIELECTRIC STRENGHT)	1500 V
ISOLAMENTO (INSULATION)	>10 MΩ
DISPERSIONE (LEAKAGE CURRENT)	<0.1 mA
MASSIMA TEMPERATURA SUL TUBO (MAXIMUM TUBE WORKING TEMPERATURE)	750°C

ROD – ESECUZIONI SPECIALI



USCITA FLESSIBILE

Tutti i riscaldatori possono essere costruiti con connessione cavi interna.

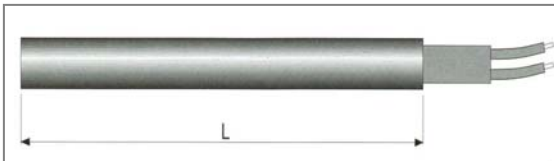

PROTEZIONE CAVI CON GUAINA IN VETRO - SILICONE

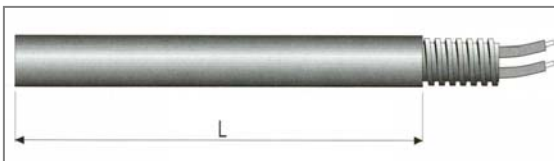

PROTEZIONE CAVI CON GUAINA METALLICA FLESSIBILE

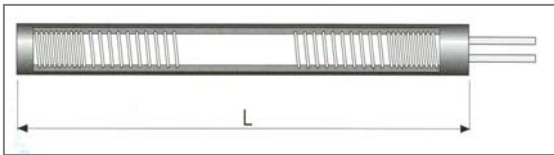

DISTRIBUZIONE DI POTENZA E ZONE NEUTRE SECONDO ESIGENZA

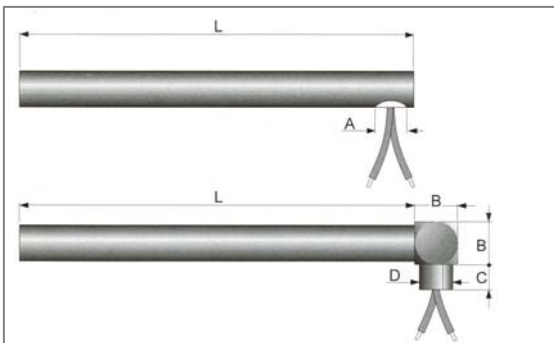

USCITA CAVI AD ANGOLO RETTO

DIA.	6,5	8	10	12,5	16	20
A	5	6	6	8	10	12
B	8	10	12	14	18	22
C	6	7	7	8	10	10
D	8	10	10	12,5	16	16

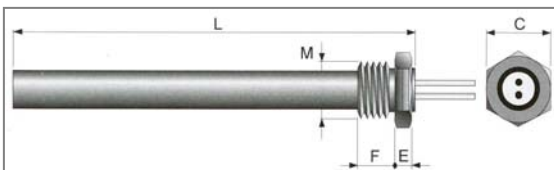

BOCCOLA FILETTATA CON TESTA ESAGONALE IN ACCIAIO INOX

DIA.	6,5	8	10	12,5	16	20
M	10x1	12x1,5	14x1,5	16x1,5	20x1,5	27x1,5
F	7	9	9	10,5	13	13,5
E	3,5	4	4	4,5	5	6,5
C	12	14	17	19	24	30